

---

# Operation Manual

## FreeStyle T42/T22 LED

(True Match® Firmware 5.0)

(RDM)



CFX-F482



FS-48  
FS-24



LED-140X



**KINO FLO**  
Lighting Systems

# FreeStyle T42/T22 Systems



## **SYS-FT42U**

FreeStyle T42 LED DMX System, Univ

## **SYS-FT22U**

FreeStyle T22 LED DMX System, Univ

### **FreeStyle T42/T22 LED System consists of:**

- 1 FreeStyle T42/T22 Fixture
- 1 Mounting Plate
- 1 FreeStyle/4 Extension Cable
- 1 LED Controller
- 2 FreeStyle 4ft (or 2ft) LED Tubes

## FreeStyle T42/T22 System Components



**CFX-F482** FreeStyle T42 Fixture

**CFX-F242** FreeStyle T22 Fixture



**FS-48** FreeStyle 4ft LED Tube

**FS-24** FreeStyle 2ft LED Tube



**MTP-KG41** KinoGrip 41K Mount w/ 3/8" Pin (10mm)



**X12-F425** FreeStyle/4 Extension, 25ft



**LED-140X-120U**  
FreeStyle 140 LED DMX Controller, Univ 120U

**LED-140X-230U**  
FreeStyle 140 LED DMX Controller, Univ 230U

# Power



## AC Input

The FreeStyle 140 LED DMX Controller is powered AC and includes an IEC connection. It also includes a 12ft power cord with a locking IEC connector.

The FreeStyle 140 LED DMX has a built-in power supply with universal input from 100-240VAC.

## Ambient Operating Temperature

The FreeStyle 140 LED DMX is designed to operate at temperatures from 14°F to 104°F (-10°C to 40°C).



## DC Input

The FreeStyle 140 LED DMX can also be operated on 24VDC (input range 18-36VDC) through a 3-Pin XLR. The pin polarity is:

- Pin # 1 – Ground
- Pin # 2 + 18-36VDC
- Pin # 3 not used



## Note:

A low voltage warning will display if input DC voltage is under 18VDC. Photo example: **LOW VDC: 16**

# FreeStyle Fixture Assembly

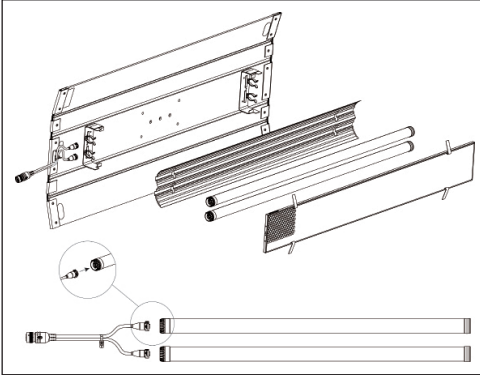

The FreeStyle T42/T22 fixture is comprised of a Louver, Reflector and Tube Harness.

The Louver and Reflector are held in place with Velcro fasteners. The Tube Harness is secured by means of a  $\frac{1}{4}$  turn fastener.



The FreeStyle Reflector has a unique design to accommodate the aluminum channel on the back of the FreeStyle tube. It provides even light distribution and maximizes light output. In addition, it acts as a heatsink and allows the FreeStyle Tubes to run cooler.

# FreeStyle Harness



## FreeStyle Harness:

Align arrows on harness connector with tube. Push and click into place. To remove harness connector, turn locking ring to the left and pull.

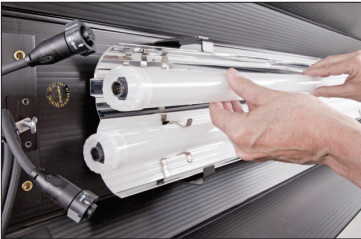

Push tubes into the fixture's tube holder clips. The tubes can operate independent of the fixture allowing them to be built into sets or custom soft boxes or hand-held as a single tube for an eye-light.

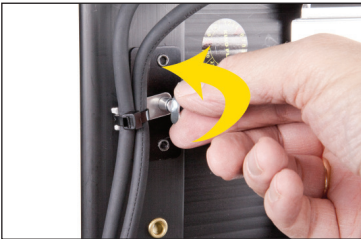

## To Release the Tube Harness

Rotate the  $\frac{1}{4}$  turn fastener clockwise to release harness.



The harness connects directly to the controller. Connect the harness to the controller. Align the key ways on the harness connector with the oval **Logo** at the top with the circular receptacle on the ballast. Rotate the silver locking ring until it clicks into the lock position.



# Extension Cable



X12-F425

The FreeStyle LED fixture can operate remotely from the controller with the extension cable up to 50ft (2 x 25ft). Remote operation of the controller provides more rigging options.

To connect Harness to Extension Cable, align oval **Logos** on the Harness and Extension. Rotate the silver locking ring until it clicks into the locked position.

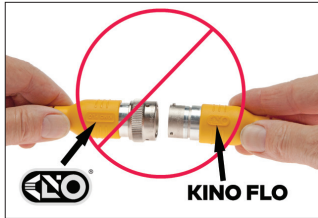

# Mounting Controller



The Controller can be mounted to a stand with a ballast mount accessory, **MTP-BAL1** and mafer clamp.

**MTP-BAL1**



# Mounting the Fixture



The standard mount (**MTP-KG41**) comes with a 3/8" Lollipop that clamps into a grip head. The ball and socket mount allows the fixture to be oriented in a broad range of angles.



Align the center pin of the mounting plate to the center hole on the mating plate.

Rotate plate clockwise until the four shoulder rivets drop into the receptacle. A locking pin will snap into place when the plate is properly seated.

The **yellow wire loops** provide attachment points for a safety chain.



**To remove the plate**, pull up on the locking pin and reverse the mounting procedure.

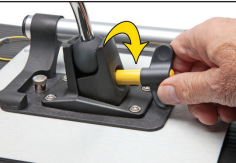

Turn the knob to loosen or tighten the mount.



Lollipops are interchangeable.

**MTP-L** Kino 41 Lollipop w/ 3/8" Pin (10mm)

**MTP-LBC** Kino 41 Lollipop w/ Baby Rcvr Curve (16mm)

**MTP-LBS** Kino 41 Lollipop w/ Baby Rcvr Short (16mm)



# Mounting LED Tubes

FreeStyle LED Tubes can operate inside the fixture or independently with only the wiring harness. The LED Tubes have an aluminum rail that can be used as an access point for mounting accessories:

<b>MTP-F100</b>	FreeStyle Tube Mount – Anchor
<b>MTP-F101</b>	FreeStyle Tube Mount – Baby Pin
<b>MTP-F102</b>	FreeStyle Tube Mount – Wall Plate
<b>MTP-F103</b>	FreeStyle Tube Mount – Hanging Kit 4pk (Wire not included)
<b>MTP-F103W</b>	FreeStyle Tube Mount – Hanging Wire, 50ft
<b>MTP-F105</b>	FreeStyle Tube Mount – Combiner
<b>MTP-F200</b>	FreeStyle Tube -Ball Mount
<b>MTP-F201</b>	FreeStyle Tube - Floor Stand



**MTP-F100**



**MTP-F101**



**MTP-F102**



**MTP-F103**



**MTP-F103W**



Insert into T-slot. Insert wire all the way down. Pull up wire until it latches. Press down pin to release wire.



**MTP-F105**



The FreeStyle Tube Mount Combiner (**MTP-F105**) can mount two LED tubes. Insert into T-slot and tighten thumbscrew. Several Combiners can be combined for custom rigging applications.



**MTP-F200**



**MTP-F201**



The FreeStyle Tube Ball Mount (**MTP-F200**) includes a baby receiver and works together with the FreeStyle Tube Floor Stand (**MTP-F201**) which includes a baby pin.



The FreeStyle Tube Ball Mount (**MTP-F200**) can also be used in conjunction with a baby pipe clamp.

## Applying Louver



The Louver is fastened to the fixture with 4 Velcro straps.

# Control Panel - White Mode

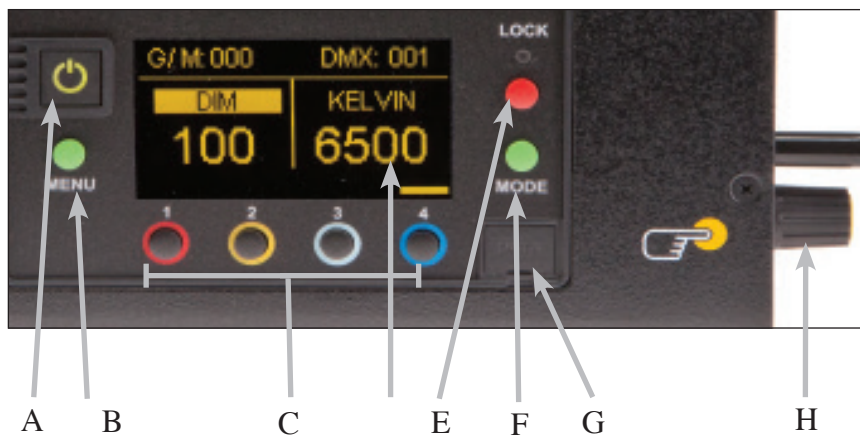

- A) On /Off:** **On** = Green light displayed. **Off** = Red light displayed. The display and all menu settings can be operated while the power button is in the Off position, as long as power is applied to the controller. The On /Off button only controls the light source.
- B) Menu:** Provides access to menu options such as General settings, Reset, DMX, DMX Wireless, Camera LUT and Color Space.  
Shortcut: While on control screen, press and hold for 3 seconds to switch through menus (**White, Gels & Hue, RGB, CIE xy** and **FX**).
- C) Preset Buttons:** Factory defaults left to right are: 2700K, 3200K, 5000K and 6500K. G/M default value is 000. User can also use these preset buttons to store custom Kelvin and G/M settings.
- D) Display:** Provides access to Dim, Kelvin, G/M, and DMX channel.  
Factory reset will show: Dim = 10%, Kelvin = 2700K, G/M = 000, DMX = 001.
- E) Lock:** Press the **Lock** button to disable all buttons and Control knob.  
Press for 3 seconds to restore displayed presets to default factory settings.
- F) Mode:** Press to navigate from Dim to Kelvin and G/M settings.  
When in sub-menus, pressing Mode always returns you to main display.  
When DMX is applied, use Mode to access DMX channel on main display.  
Shortcut: Long press will bring you back one step.
- G) Data Port:** Mini B USB for firmware updates.
- H) Control Knob:** Manually adjusts Dim, Kelvin, G/M levels and DMX address.  
Press the Control knob to toggle between **Fine** and **Coarse** increments or when selecting options within menus.
- DMX Note:** The LED-140X has an **"AUTO TERMINATE"** feature.  
The last fixture that does not have an XLR cable attached to the DMX "Out" port will automatically terminate.

# Control Panel - Gels/Hue Mode



## Gels/Hue Mode

### A) Menu:

Provides access to menu options such as General settings (**Gels/Hue Mode**), Reset, DMX, DMX Wireless, Camera LUT and Color Space.

Shortcut: While on control screen, press and hold for 3 seconds to switch through menus (**White, Gels & Hue, RGB, CIE xy and FX**).

### B) Preset Buttons:

Factory defaults left to right are: 2700K, 3200K, 5000K and 6500K.

G/M default value is 000. User can also use these preset buttons to store custom Kelvin between 2500K and 9900K and custom G/M, Gel, Hue and Saturation settings.

### C) Display:

Provides access to Dim, Kelvin, G/M, Gel, Hue/Saturation and DMX channel. Factory reset will show: Dim = 10%, Kelvin = 2700K, G/M = 000, DMX = 001.

### D) Mode:

Press to navigate from Dim to Kelvin, G/M, Gel, Hue and Saturation settings. When on the Gel function, pushing the Control knob in/out will apply the gel or remove the gel. When in sub-menus, pressing Mode always returns you to main display. When DMX is applied, use Mode to access DMX channel on main display. Shortcut Tip: Long press will bring you back one step.

# Control Panel - RGB Mode

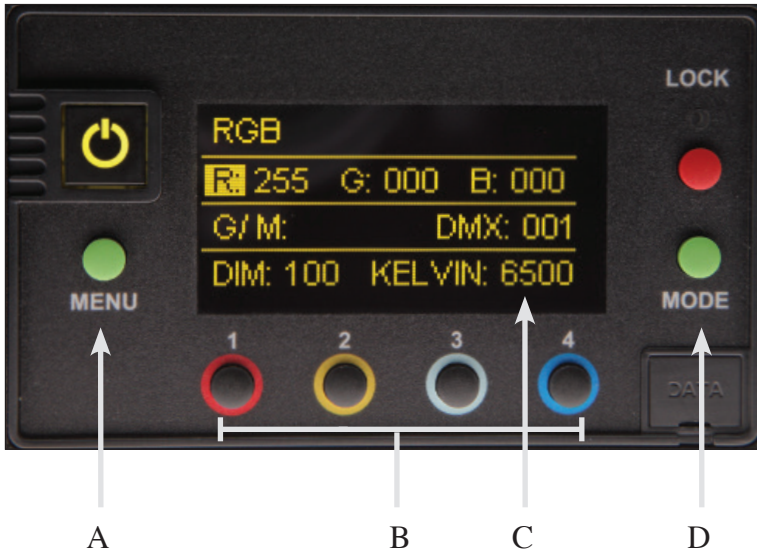

## RGB Mode

### A) Menu:

Provides access to menu options such as General settings (**RGB Mode**), Reset, DMX, DMX Wireless, Camera LUT and Color Space.

Shortcut: While on control screen, press and hold for 3 seconds to switch through menus (**White, Gels & Hue, RGB, CIE xy and FX**).

### B) Preset Buttons:

Factory defaults left to right are: 2700K, 3200K, 5000K and 6500K.

G/M default value is 000. User can also use these preset buttons to store custom Kelvin between 2500K and 9900K and custom G/M, and RGB settings.

### C) Display:

Provides access to Dim, Kelvin, G/M, RGB and DMX channel.

Factory reset will show: Dim = 10%, Kelvin = 2700K, G/M = 000, DMX = 001.

### D) Mode:

Press to navigate from Dim to Kelvin, G/M, RGB settings.

When in sub-menus, pressing Mode always returns you to main display.

When DMX is applied, use Mode to access DMX channel on main display.

Shortcut: Long press will bring you back one step.

# Control Panel - CIE xy

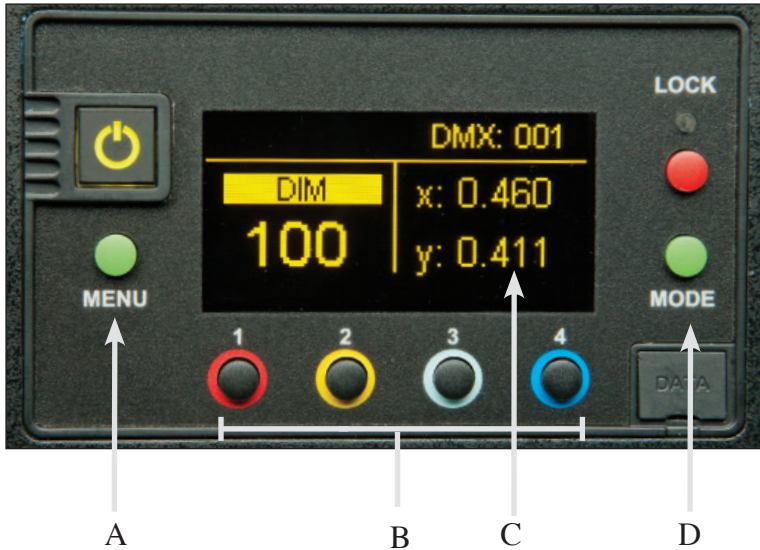

## CIE xy Mode

### A) Menu:

Provides access to menu options such as General settings (**CIE xy mode**), Reset, DMX, DMX Wireless, Camera LUT and Color Space.

Shortcut: While on control screen, press and hold or 3 seconds to switch through menus (**White, Gels & Hue, RGB, CIE xy and FX**).

### B) Preset Buttons:

Factory defaults left to right are: 2700K, 3200K, 5000K and 6500K.

User can also use these preset buttons to store custom xy settings.

### C) Display:

Provides access to Dim, CIE xy coordinates and DMX Channel.

Factory reset will show: Dim = 10%, x = 0.460 , y = 0.411, G/M = 000, DMX = 001.

### D) Mode:

Press to navigate from Dim to xy settings. When in sub-menus, pressing Mode always returns you to main display. When DMX is applied, use Mode to access DMX channel on main display. Shortcut: Long press will bring you back one step.

# Control Panel - FX (Effects)

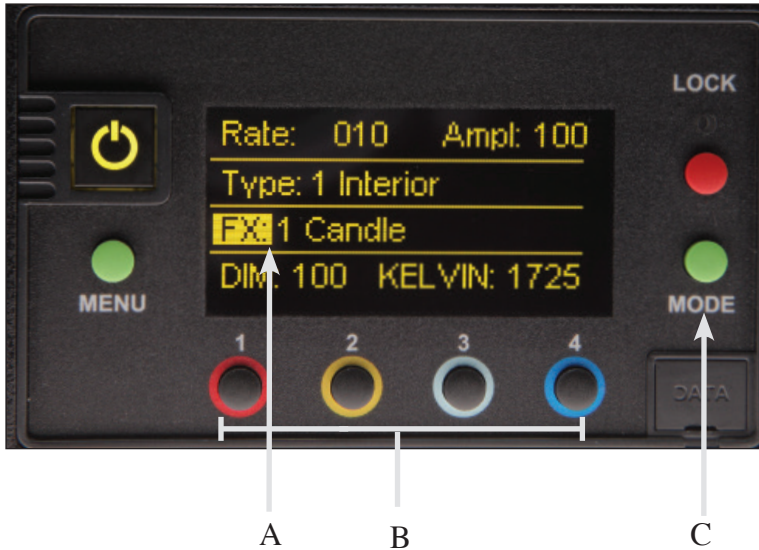

## FX (Effects) Mode

FX mode provides access to effects including Candle, Fire, TV, Police, Lightning, Paparazzi, Pulse and Scroll. Candle mode used as an example:

### A) FX Option:

Choose the desired FX Mode by rotating the control knob. When on the desired effect, there will be several pre-programmed effects as well as control parameters that can be altered.

### B) Preset Buttons:

In FX Mode, **Kelvin** custom settings and any control functions displayed such as **Rate** and **Amplitude (Ampl)** can be saved as a preset. Chosen values can be assigned to any preset button by holding down the desired button for 3 seconds. The Kelvin display will flash once the setting is registered.

To restore presets to default factory settings, choose **Reset** under **General** settings and **Clear Presets**. This method will reset all buttons in all Modes. Shortcut: If only want to clear presets for **Candle** Mode, hold **Lock** button for 3 seconds while Candle mode is displayed.

### C) Mode:

Press to navigate from Dim to Kelvin and FX settings.  
Shortcut: Long press will bring you back one step.

# Camera LUT



The **Camera LUT** (Look-up Tables) feature harmonizes the Kino Flo light sources to the camera. Depending on the camera and the Kelvin setting, some differences are very subtle, while others can be more dramatic.

The corrections are applied as a **CIE xy** correction at each CCT (Kelvin) setting. The default setting is targeting the CIE xyz response (human eye).

Press the green menu button to the left of the display screen and scroll down to **Camera LUT**, then press the control knob. Menu with camera selection will be displayed. Turn the control knob and press to select camera setting:

- C1 Arri Alexa**
- C2 Sony Venice**
- C3 Panavision DXL**
- C4 Panasonic Varicam**

The camera code (C1 for Arri Alexa), for example, will appear on the main menu between **DIM** and **CCT** to designate that a camera setting is active.

Note: When the controller is reset, the camera settings will go to Kino Flo Default mode.



# Color Space



**Color Space** defines the RGB color space used and only affects color – not Kelvin. It is used in **RGB** mode and **Hue Angle** and **Saturation**. There are a few instances in the FX (Effects) mode that are also affected when color is used. The RGB color space defines the value of Red, Green, and Blue primaries (in CIE xy) and the white point is fixed at 6500 Kelvin.

Press the green menu button to the left of the display screen and scroll down to **Color Space**, then press the control knob. Menu with color selection will be displayed. Turn the control knob and press to select Color Space options:

**rec 709 / sRGB**  
**P3 D65**  
**rec 2020**

The color space **rec 709 / sRGB** is commonly used on computer monitors, SDTV and HDTV television. There are slight gamma variations between rec 709 / sRGB, but not enough to separate into 2 color spaces.

The color space **P3 D65** is a common color space for digital movie projection. The color space **rec 2020** is used in ultra high definition television (UHDTV).

The color space is used when the controller is set to the RGB mode and when set to the Hue Angle/ Saturation mode.

In **RGB** mode – the color space designation will be displayed at the top of the menu. When changing the Red, Blue or Green values, the Kelvin will be locked in at 6500 for all color spaces. When the Kelvin is locked in, CCT will be displayed as CCT\*. When using Green/Magenta the CCT value is unlocked and color space selection has no impact.

In **Hue Angle/Saturation** mode – the color space designation will be displayed on the Gel line and GEL will be displayed as GEL\* and CCT will be displayed as CCT\*. The Color space will be displayed only when Hue Angle and Saturation are being used. When using Green/Magenta or Gel, the CCT will be unlocked and color space selection has no impact.

# Accessories



**SYS-BK12** Block/KF21 Single Battery System, 140Whr, 28.8V (2 x Battery)

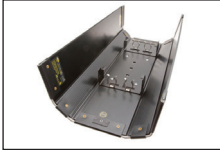

**FIX-F482** FreeStyle T42 Fixture Shell Only

**FIX-F242** FreeStyle T22 Fixture Shell Only



**HAR-FS2** FreeStyle T42/T22 Harness

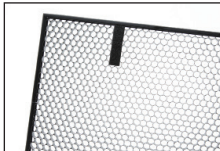

**LVR-SL490-P** FreeStyle T42 Louver/HP, 90°

**LVR-FT2290-P** FreeStyle T22 Louver/HP, 90°



**MTP-901** Savior Mini Clamp & Lock Screw Pin (16mm)



**MTP-902** KF/LED Controller Mount Assembly 2



**MTP-903** KF/LED Controller Mount Assembly 3



**MTP-F100** FreeStyle Tube Mount – Anchor



**MTP-F101** FreeStyle Tube Mount – Baby Pin



**MTP-F102** FreeStyle Tube Mount – Wall Plate



**MTP-F103** FreeStyle Tube Mount – Hanging Kit 4pk



**MTP-F103W** FreeStyle Tube Mount – Hanging Wire, 50ft



**MTP-F200** FreeStyle Tube - Ball Mount



**MTP-F201** FreeStyle Tube - Floor Mount



**MTP-BG41** KinoGrip 41K Mount w/ Baby Receiver (16mm)



**MTP-BG41S** KinoGrip 41K Mount w/  
Baby Receiver Short (16mm)



**MTP-BAL1** Kino Bal/Led Controller Mount (16mm)



**MTP-BRA** Baby Right Angle Offset (5/8" Pin)



**MTP-L** Kino 41 Lollipop w/ 3/8" Pin (10mm)  
**MTP-LBC** Kino 41 Lollipop w/ Baby Rcvr Curve (16mm)  
**MTP-LBS** Kino 41 Lollipop w/ Baby Rcvr Short (16mm)



**REF-F482** FreeStyle T42 Reflector  
**REF-F242** FreeStyle T22 Reflector



**XLR-310** 3-Pin Xlr DC Power Cable, 10ft



**STD-M30** Medium Duty, 3-Rise 30"

**STD-M36** Medium Duty, 3-Rise 36"



**STD-D1** Reverse Stand

## Cases



**KAS-FT54S** FreeStyle T44 Fixture (3) Ship Case

**KAS-FT54L** FreeStyle T44 Fixture (5) Ship Case

**KAS-FT23** FreeStyle T24 Fixture (3) Ship Case



**KAS-KFC** Ballast and Cable Crate w/ Lid

## Fixture Specifications



**FreeStyle T42**

**CFX-F482** FreeStyle T42 LED Fixture

**Weight w/ Tubes:** 7.7 lb (3.5kg)

**Dimensions:** 52 x 3.5 x 8" w/ 5.5" barndoors  
(132 x 9 x 20cm w/ 14cm barndoors)



**FreeStyle T22**

**CFX-F242** FreeStyle T22 LED Fixture

**Weight w/ Tubes:** 4.7 lb (2.1kg)

**Dimensions:** 28 x 3.5 x 8" w/ 5.5" barndoors  
(71 x 9 x 20cm w/ 14cm barndoors)

## LED Tube Specifications



**FS-48, FS-24**

**FS-48** FreeStyle 4ft LED Tube

**Weight:** 1 lb (0.45Kg)

**Length:** 48" (1200mm)

**Diameter (Socket Base):** 1.5" (38mm)

**Diameter (Including Rail):** 1.75" (44.5mm)

**FS-24** FreeStyle 2ft LED Tube

**Weight:** 0.5 lb (0.2Kg)

**Length:** 24" (600mm)

**Diameter (Socket Base):** 1.5" (38mm)

**Diameter (Including Rail):** 1.75" (44.5mm)

## LED Controller Specifications



**FreeStyle 140 LED  
DMX Controller**

**LED-140X** FreeStyle 140 LED DMX Controller

**AC Input Voltage:** 100~240VAC 50/60Hz, 150W

**Amperage VAC:** 1.25A at 120VAC, 0.65A at 230VAC

**DC Input Voltage:** 18-36VDC, 150W

**Amperage VDC:** 6.25A at 24VDC

**Kelvin Range:** 2500K-9900K

**Dimming Range:** 100%-1%

**Weight:** 4.5 lb (2kg)

**Dimensions:** 9.5 x 7.5 x 2.5"  
(24 x 19 x 6cm)

**FCC Part 15 Verification:**

This device complies with Part 15 of the FCC Rules. Operation is subject to the condition that this device does not cause harmful interference.

**FCC Part 15 Declaration of Conformity:**

This device complies with Part 15 of the FCC Rules. Operation is subject to the following two conditions: (1) this device may not cause harmful interference, and (2) this device must accept any interference received, including interference that may cause undesired operation.



KINO FLO, INC  
**FreeStyle T42/T22 & LED-140X**  
ID: XRSCRMXTIMO101  
IC: 8879A-CRMXT101

The light source of this luminaire is not replaceable; when the light source reaches its end of life the whole luminaire shall be replaced. The luminaire is intended for professional use only.



For latest Warranty information and Certifications,  
see Kino Flo website at [www.kinoflo.com](http://www.kinoflo.com).

**Environmental: Disposal of Old Electrical & Electronic Equipment.**



This symbol on the product or on its packaging indicates that this product shall not be treated as household waste. This product is made of recyclable materials and should be disposed of in accordance with governmental regulations.